

Collection

Our favorite



Solembra
EXCEPTIONAL BIOCLIMATIC PERGOLA

CATALOGUE
Residential



“ Together,
let's bring to life your project...

even the most exceptional one !



EXCEPTIONAL BIOCLIMATIC PERGOLA MAKER & DESIGNER

Maison Solembra _____	05-11
The DNA & Solembra's values _____	06-07
6 reasons why to choose us _____	08-09
Solembra's support all along _____	10-11
The bioclimatic pergola _____	12-13
Solembra's ranges _____	14-29
So'lzzy range _____	16-19
So'Me range _____	20-23
So'Design range _____	24-27
Comparative table range _____	28-29
Collection "Our favorite" _____	30-51
Solembra's technical expertise _____	52-59
Types of pergolas _____	54-55
Poles & bracing _____	56-57
Solembra's taylor-made _____	58-59
Endless aesthetic possibilities _____	60-75
Arches & roof overhangs _____	62-63
Height & depth effects _____	64-65
Aluminum screens & colours _____	66-67
Powder coating colour char _____	68-71
Closing systems _____	72-73
ZIP blinds colour chart _____	74-75
Ideas to live _____	76-77
Solembra's accessories _____	78-81
Lighting systems _____	79-81
Our customers talk about it... _____	82-83
Solembra's assets _____	84-85
Solembra's quality warranty _____	86
Solembra.fr website _____	87

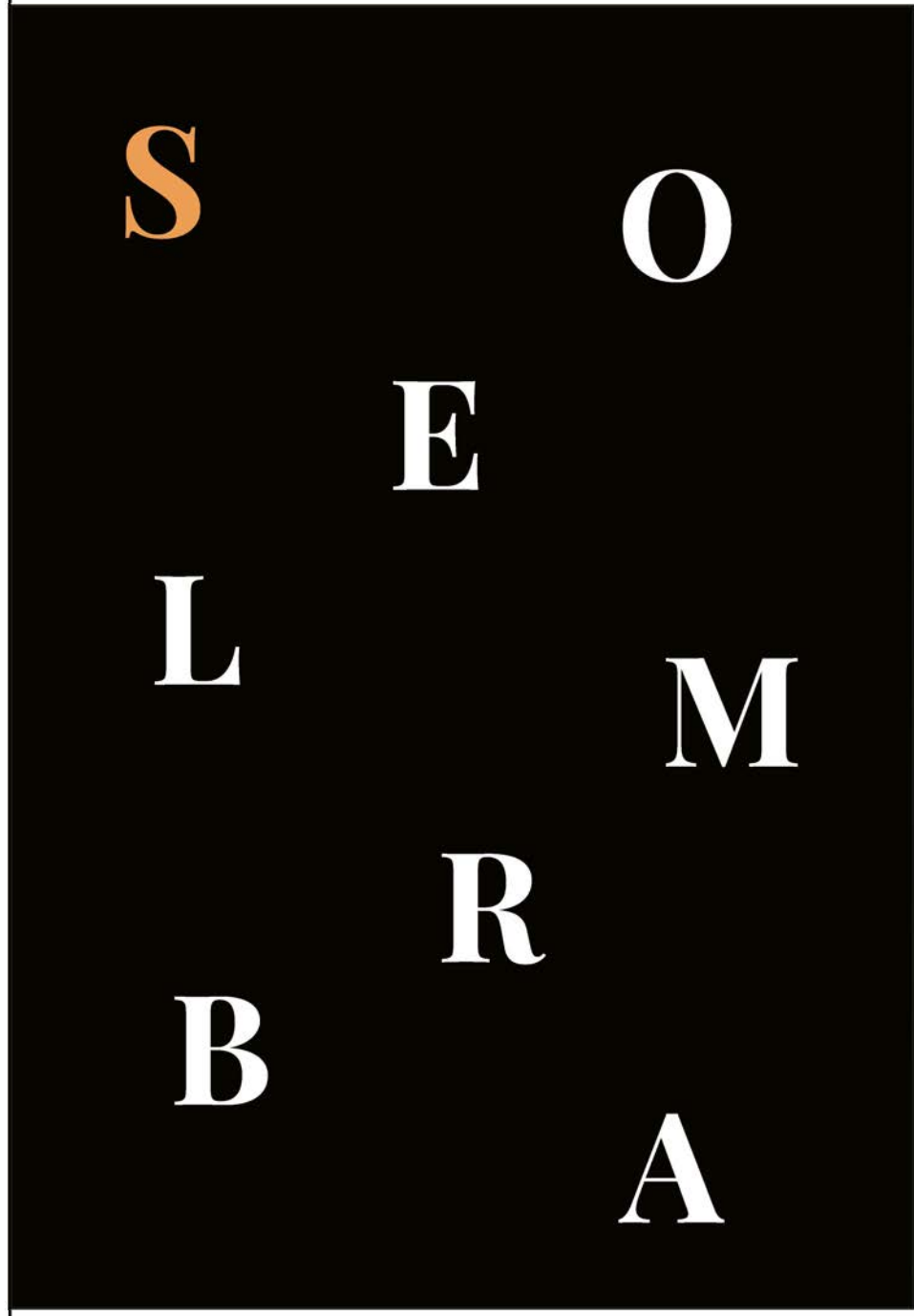



6 reasons to choose Solembra





1/ Best weather resistance on the pergola market

We are constantly developing ingenious new technologies to meet the major challenge of climate change.

2/ Best axes' hold on the pergola market

We offer innovative and technical solutions to combine the fineness and robustness of aluminium with high-quality stainless steel, proof of solidity and safety.

3/ Bioclimatic pergola expert & pursuit of excellence

We only manufacture bioclimatic pergolas and we are committed to offer perfection on this product, a reflection of all our expertise.

4/ Adaptation, attention & advice throughout your project

A single and dedicated contact person supports you from the first meeting to delivery. Designer, commercial and technician, he/she becomes the expert of your project !

5/ Solembra's quality commitment

We ensure internally the entire project (advice, measurements, plans, design, manufacture, installation, after-sales service, maintenance, etc.).

A secure project, mastered at each stage and guaranteed deadlines.

6/ Exceptional technical & aesthetics' solutions

Our speciality is to carry out exceptional and tailor-made projects.

We excel in the art of turning your desires into reality, with unique technical and aesthetic solutions.

With you all along ...

1 UNIQUE SOLEMBRA CONTACT PERSON...



Step 1

MEET YOUR DEDICATED CONTACT
& DEFINE TOGETHER YOUR PROJECT

Because we are close to our clients and we like to create a relationship of trust, our designer-technician dedicated to your project becomes your special contact from your first phone call or physical meeting.

Attentive to your wishes and your home technical constraints, he/she moves on with you and advises you on the technical and aesthetic aspects of your project.

You also benefit from his expert advice on the best blades orientation to optimize the "bioclimatic" effect, based on the house orientation and the pergola built in your home.

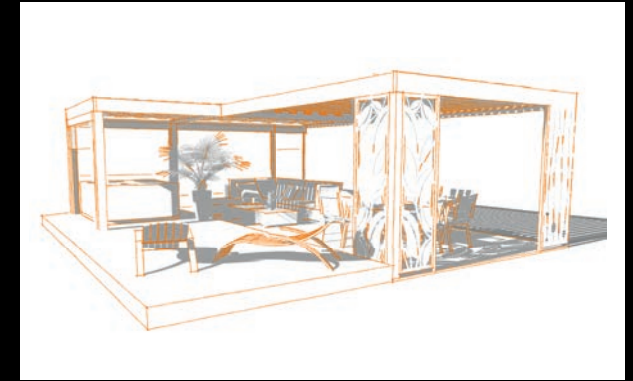

Step 2

WE PLAN, DESIGN
& BUILD OF YOUR PERGOLA

By precisely taking into account your expectations and your needs, and after taking the measures, your contact person designs your project in 3D plans, or in projection images, using our company design office.

You can visualize your future Solembra bioclimatic pergola in its environment!

Once the pergola of your dreams has been approved together, after adjustments if necessary, we start the production in our factory located in France, in order to always offer you a high-end pergola made with the best materials on the market.

A real control of our quality and our deadlines.

...FULLY DEDICATED TO YOUR PROJECT !



Step 3

OUR TEAM COMES TO YOUR HOUSE TO INSTALL YOUR PERGOLA ON A SECURE SITE

The installation of all our bioclimatic pergolas is carried out by our own expert Solembra team (employees and trained in our company), for a perfect and high-end result.

An outstanding organization, the latest technical equipment and a strong team spirit make our sites a highly secure and pleasant place, for great efficiency and capability to meet our deadlines.

Your designer contact, also trained in the installation of pergolas, can go to highly technical installations to observe the conformity of his creation and check that Solembra quality remains perfect.



Step 4

WE MEET FOR DELIVERY & TRAINING

Once the pergola is settled, we deliver your pergola and make sure you are fully satisfied with the project. The documents signature launches your ten-year guarantee.

We give you the remote control followed by a training on the operation and maintenance of your bioclimatic pergola for an optimal use in complete safety.

Our pergolas are fully evolutive & flexible over time, adapting to your life projects and desires.



Step 5

WE DIRECTLY DEAL WITH OUR AFTER-SALES SERVICE & PRODUCTS WARRANTY

Again, Solembra follows your project all along, therefore, takes care of your pergola after-sales service.

Stop wasting your time !

We will know how to support you and find solutions whenever you need... and if you wish to upgrade your pergola, you can directly get in touch with your dedicated contact for your future projects.

As a designer, commercial and technician, he/she will be able to answer to all of your questions about the project and above all, help you create the perfect pergola that suits you.

The satisfaction of our clients is our priority!

A bioclimatic pergola at home ?

8 REASONS TO GIVE IN



- 1 / Give life to your outdoor spaces and enjoy them in all seasons!
- 2 / Save energy by regulating the adjoining rooms' temperature in your home.
- 3 / Create a protected and secured living space with a durable aluminium structure designed to shelter from the sun and resist bad weather.
- 4 / Privilege your comfort of life with a fully control and automatic closing of the blades in case of rain.
- 5 / Get a natural ventilation to avoid a "veranda effect" and enjoy your terrace even in hot weather.
- 6 / Control the sunshine all year thanks to its adjustable blades and maximize in your house an appropriate intake of natural lights during winter.
- 7 / Brings opening and privacy, enjoy blue sky under your pergola and benefit from the zip blinds which will allow you to see without being seen!
- 8 / Design your exterior and beautify your home with a unique and beautiful bioclimatic pergola.



The Solembra “bioclimatic” effect

In summer, the bioclimatic effect captures fresh air under the pergola and protects from the sun.

In mid-season, blades trap the sun for a cool temperature under the pergola and protect from sudden bad weather.

In winter, the pergola provides daylight and heat to the house.

Meets RT 2012 requirements

SUN & WEATHER PROTECTION / Being safe and secure under your pergola



The bioclimatic pergola provides sun and bad weather protection (rain, wind, etc.). Its blades, even half-opened, stop direct sunlight for an optimal protection. In closed position, it blocks the rain while directing water to the drains. A safe living space!

NATURAL VENTILATION / Breathe under your pergola even in summer

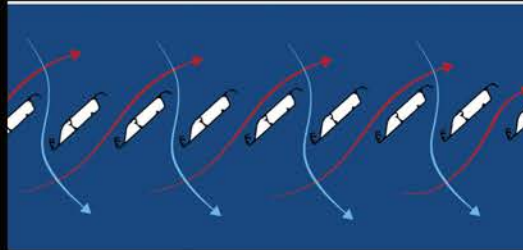

The bioclimatic pergola creates natural ventilation by avoiding the “veranda” effect. With the half-opened blades, the heat is eliminated and fresh air is trapped under the pergola while providing a complete shadow below. It is cooler under the bioclimatic pergola and a slight breeze can be felt. The bioclimatic pergola offers the possibility to enjoy a blue sky, having the feeling of openness while staying in the shadow and in a cool place. Comfort guaranteed!

BRIGHTNESS REGULATION / Unlimited natural daylight

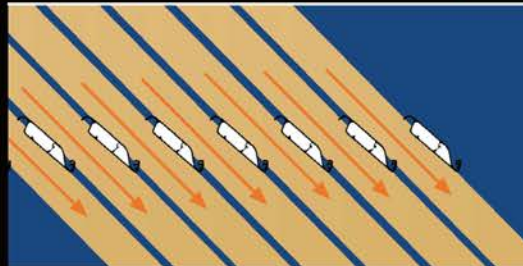

In winter / one of the main advantage of Solembra pergola is to let in the light inside the house thanks to the blades orientation between 150° and 160°. The sun reverberation on the bioclimatic pergola blades will provide maximum sunshine in the adjoining room. No more darkness in winter!

In summer / the adjustable blades will regulate the intensity of natural light, allowing you to be outside, eat outside without being blinded by the sun. Stop living in obscurity with closed shades in summer!

TEMPERATURE REGULATION / Save energy

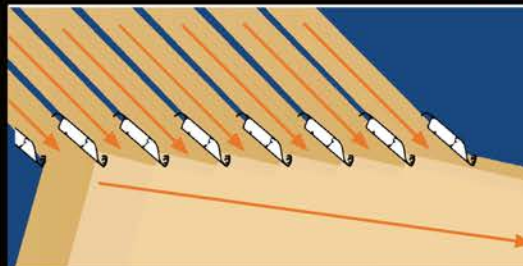

In winter / leant to the facade, the pergola will provide indirect sunlight to the adjoining room, with sun reverberation on the blades: more sun, light and heat. Gain a few degrees inside, in winter!

In summer / heat brought by the sun is eliminated by the half-opened blades, which allows you to be outside without suffering from heat, while providing a complete shadow. It helps maintain freshness in the adjoining rooms and reduces the air conditioning needs. Enjoy your exteriors in summer, even during intense heat!

A range
for each of
your desires

So'Izzy

The bioclimatic pergola with
standard dimensions & colours,
at the best price...



Solembra's quality

So'Me

The tailor-made
bioclimatic pergola
that suits you the best...



Solembra's signature

So'Design

The exceptional & creative
bioclimatic pergola
with no limit...



Solembra's excellence

So'izzy



Solembra's quality

So'Izzy

Our bioclimatic pergola
with standard dimensions and colours
to guarantee Solembra's quality,
at the best price.





So'Izzy Features

Bioclimatic pergola up to 32m²

Standard dimensions

Max height 3 000 mm / Max width 6 800 mm

1 or 2 modules of adjustable motorized blades from 0 to 160° with remote control

Leant to the house facade

Poles in angles / Dim. 110x110 mm

Standard colour blades / Pure White (RAL 9010MAT)

R9010MAT

Standard structure colours, 2 colours to choose from /

Anthracite Grey (RAL 7016MGV) Pure White (RAL 9010MAT)

MGV7016

R9010MAT

Available options /

LED lighting (remote-controlled), customizable ZIP blind (p.74-75),

weather sensors, electrical covers, flashing for waterproofing,

Pole 150x150 mm, self-supporting pergola

SO'ME

So'Me



Solembra's Signature

So'Me

Our emblematic & best seller
bioclimatic pergola, fully customizable,
for an outdoor that looks just like you.

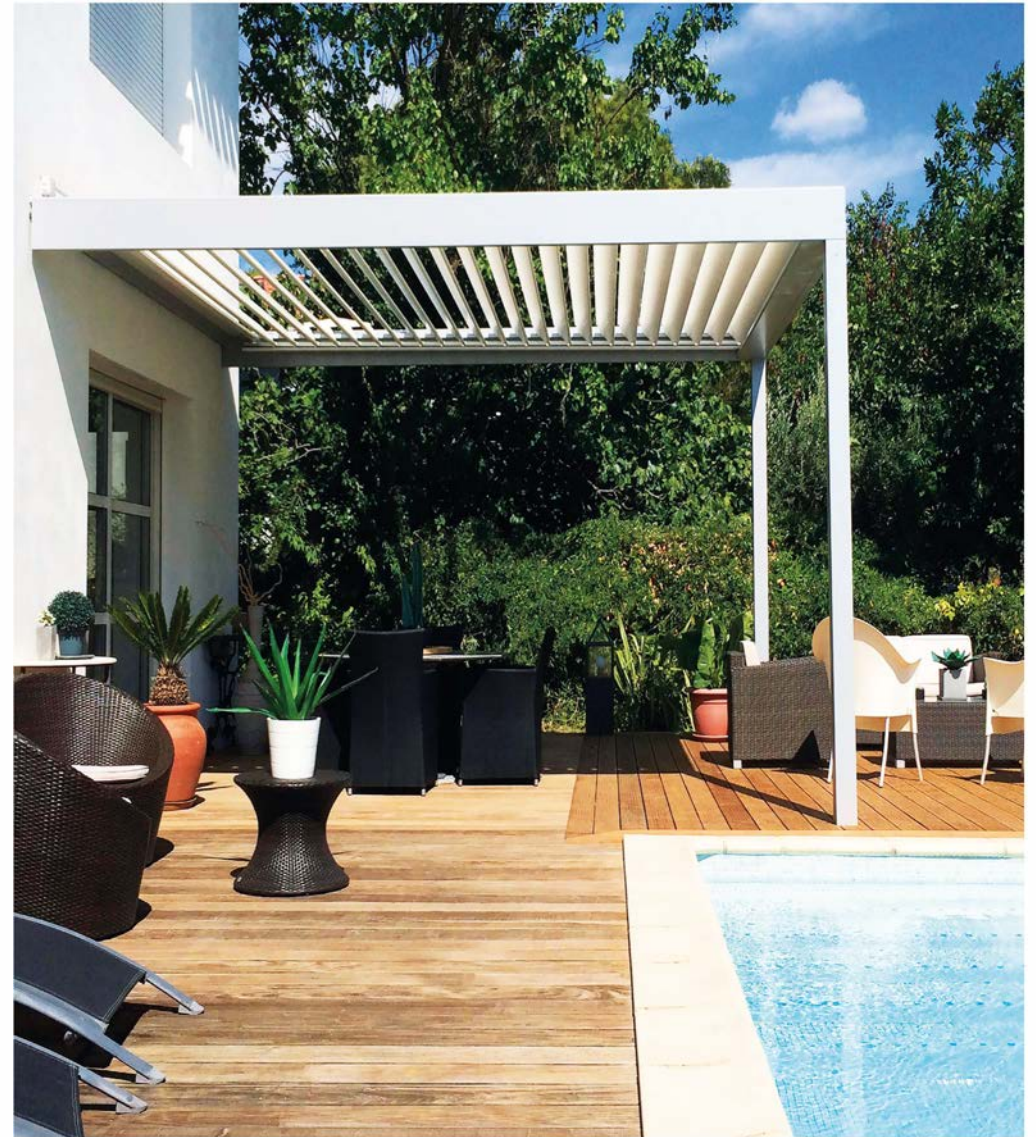

SO'ME



So'Me Features

Bioclimatic pergola up to 36m²

Custom dimensions with millimetre accuracy

Max height 3 000 mm / Max width 6 900 mm

1 or 2 modules of adjustable motorized blades from 0 to 160° with remote control

Leant to the house facade

Integrated poles into angles or moved to the sides / Dim. 110x110 mm

Standard blade colours / Pure White (RAL 9010MAT)

R9010MAT

Standard structure colours: 4 colours to choose from /

Anthracite Grey (RAL 7016MGV) or Pure White (RAL 9010MAT)

or Light Grey (RAL 9006MGV) Or Black (2100 SA)

MGV7016

R9010MAT

MGV9006

NOIR2100SA

Available options /

LED lighting (remote-controlled), customizable ZIP blind (p.74-75), weather sensors, electrical covers, flashing for waterproofing, pole 150x150 mm, self-supporting pergola, pre-wiring, etc.

+ 400 colours to choose from for the structure
possibility to mix (colour chart p. 68-71)



So'Design



Solembra's Excellence

So'Design

Our bioclimatic pergola
with unique & architectural lines
that meet each of your desires,
with no limit, for an amazing exterior!

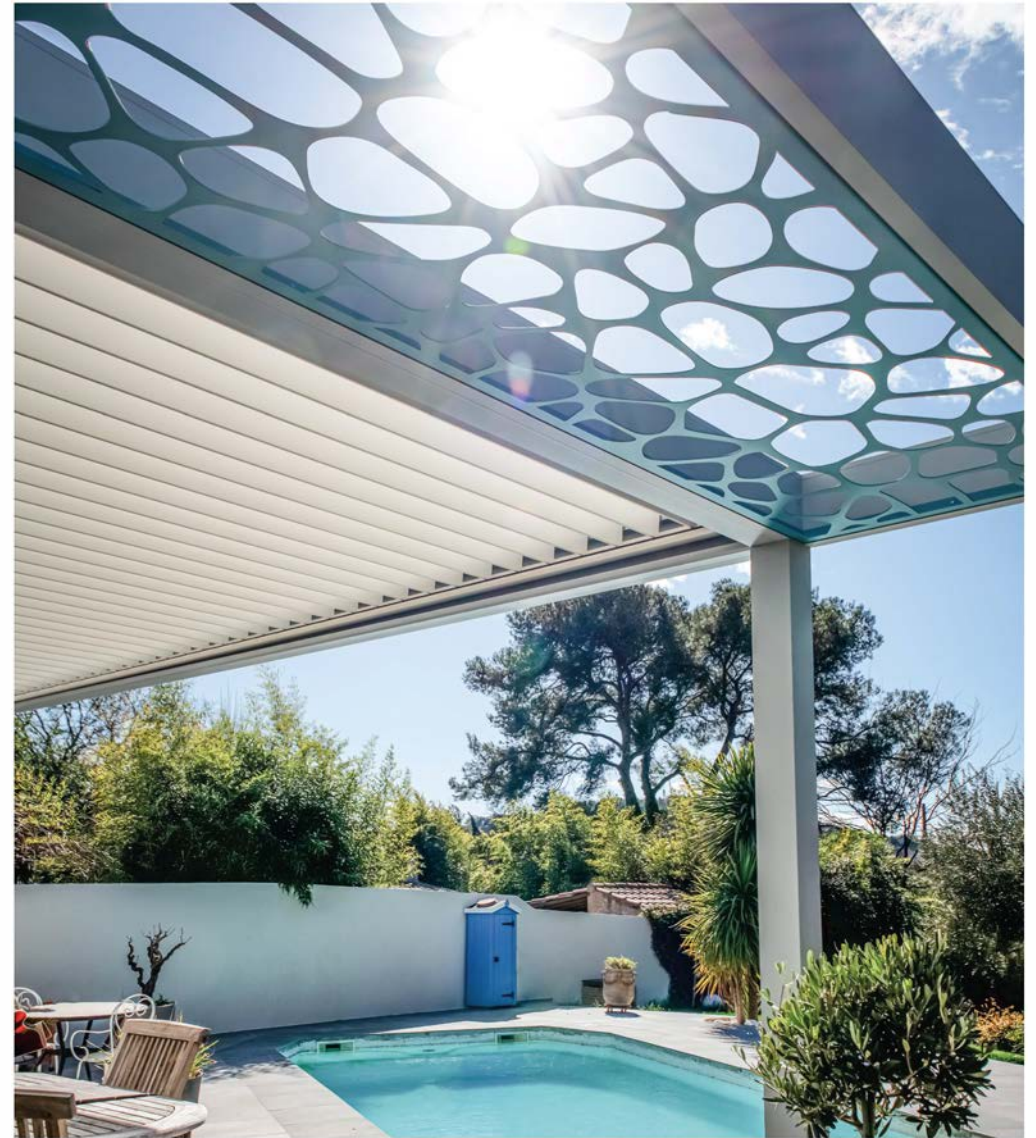



So'Design Features

Bioclimatic pergola up to 48m2

Custom dimensions with millimetre accuracy

Tailor-made height / Max width 7 900 mm

Custom-made number of modules of adjustable motorized blades from 0 to 160° with remote control

Leant to the house facade, self-supporting pergola or pre-wiring

Integrated poles into angles, offset, limited or delated (bracing)

Dim. 110x110 mm or 150x150 mm

Chipped or suspended arches simple, double, triple, roof overhang... Tailor-made decorative privacy screen

Standard blade colours / Pure White (RAL 9010MAT)

R9010MAT

Standard structure colours 4 colours to choose from /

Anthracite Grey (RAL 7016MGV) or Pure White (RAL 9010MAT) or Light Grey (RAL 9006MGV) Or Black (2100 SA)

MGV7016

R9010MAT

MGV9006

NOIR2100SA

Available options /

LED lighting (remote-controlled), customizable ZIP blind (p.74-75), glazing, privacy screen, venetian blind, weather sensors, electrical covers, flashing for waterproofing, prewiring, heater, water mist, audio system, etc.

+ 400 colours to choose from for the structure with possible mixing (colour chart p. 68-71)





So'Me



Up to 36m² / Customized dimensions with millimetre accuracy

6 900 mm

Leant / Self-supported (in option)

110x110mm / 150x150mm (in option)

Into angles / offset (max 1 000mm) / limited

Weather sensors (rain, wind) / electrical covers / pre-wiring / flashing

White (RAL 9010MAT)

4 standard colours Anthracite Grey (RAL MGV7016) / White (RAL R9010MAT) / Light Grey (RAL MGV9006) / Black (FUTURA NOIR2100SA) / In option +400 colours to choose from (p. 68-71)



Insertion photo



So'Design



Up to 48m² / Customized dimensions with millimetre accuracy

7 900 mm (solution 10 000 mm available)

Leant / Offset / Self-supported

110x110mm / 150x150mm

Into angles / offset / limited / delated (bracing)

Weather sensors (rain, wind) / electrical covers / pre-wiring / flashing

White (RAL 9010MAT)

4 standard colours Anthracite Grey (RAL MGV7016) / White (RAL R9010MAT) / Light Grey (RAL MGV9006) / Black (FUTURA NOIR2100SA) / In option +400 colours to choose from (p. 68-71)



3D plans conception to picture the installation of your pergola



Simple, double, triple, chipped of, suspended arches / Advanced frame / etc.
Glazing / Privacy screen / Venetian blade / Heater / Water mist / Audio system / etc.

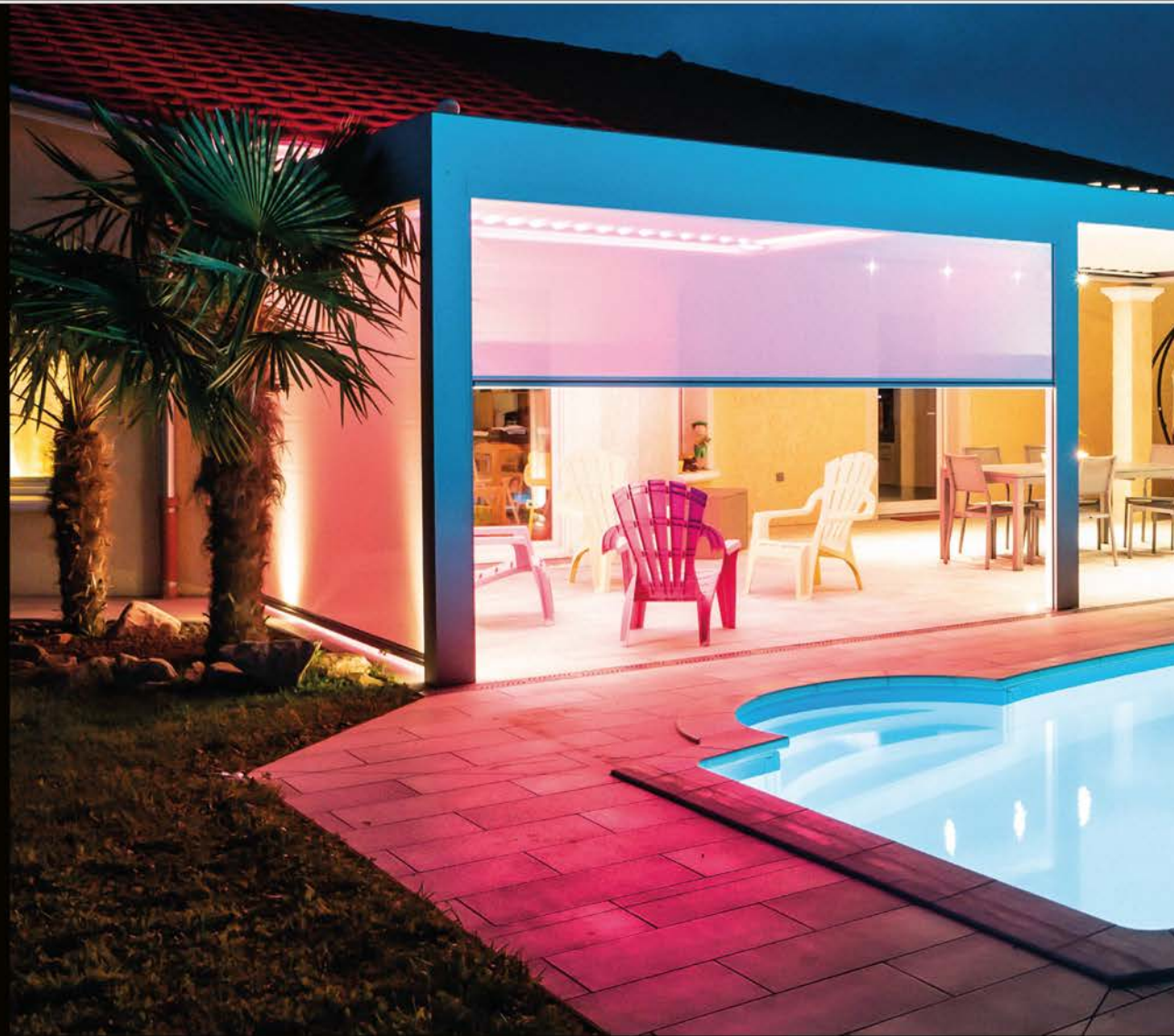



Collection

Our favorite





Exceptional setting

Architect house

Bouches-du-Rhône (13) - France

So'Design range

Technical & aesthetic solutions /

Poles' position adjusted to clear the window view, aligned with the facade /

Refined lines in harmony with the house and perfect integration with the existing concrete

arch on the right / XXL reach of of 13 m / 4 independent L-shaped blade modules

Options /

Harmonized sun-shading on the left side overlooking the bedroom



Hyphen



Contemporary architect house

Marseille (13) - France

So'Design range

Technical & aesthetic solutions /

Double symmetrical arches to give volume to the whole structure /

Double symmetrical side wings carried by bracing on the left side to create a 3m wide cantilever /

Cantilever with offset poles on the right side to avoid a "squared" visual effect /

Creation of 3 living spaces, entrance on the left, dining room in the center between the 2 arches and

relaxing area on the right / Sun-shading in front of the windows / XXL reach of 11m / Depth 4,50m

Options /

3 zip blinds (1 central + 2 laterals) to create a room / Integrated adjustable LED spotlights into the structure and wings / bicolour structure









Way of life

Contemporary architect house
Charnay-lès-Mâcon (71) - France
So'Design range

Technical & aesthetic solutions /

Offset fixing of the facade by a beam to give more amplitude to the pergola, more airy (cap of 2m) /

Carried by bracing on the wing with privacy screen to clear the tailor-made gate and hide the view from the street / XXL reach of 7m50 /

2 independent adjustable blade modules / 2m wide suspended privacy screen above the swimming pool on a 6m beam to create visual harmony

between the different spaces (same width of the pool) / Poles 150x150 mm with "seamless" bonded beam /

Sun-shading by bracing to protect the bedroom / Carpark with 10m beam carried by bracing (cf p.59)

Options / 1 central zip blind to protect the dining areas/ White LED strip



Conviviality

Renovated private house

Bourg-en-Bresse (01) - France

So'Design range

Technical & aesthetic solutions /

Perpendicular blades to maximize daylight entrance into the house facing west / 10m long beam with creation of a 650mm cantilever located in the roof overhang, facing south, swimming pool side /

Horizontal privacy screen inserted under the roof, facing south, to produce a light and shade effect and create a visual asymmetry from the garden / 2 vertical privacy screens allowing to carry and a slide for futur 6m central zip blind (scalable pergola) / 8m XXL reach between poles / Invisible floor mountings on finished slab

Options /

Red side zip blinds to protect from the wind / Adjustable LED spotlights / bicolour structure with a customized red (Ducati motorcycle)







Light & shade effect

Private house

Fuveau (13) - France

So'Design range

Technical & aesthetic solutions /

Simple arch design for an impression of volume in relation with the roof height /

Aesthetic solution with a depth offset for overall harmony /

Left side sun-shading (light and shade effect on the facade and the ground) carried by bracing to maximize the terrace area
+ 1 decorative privacy screen on the right side /

Independent blade modules for exposure according to the rooms (kitchen and living room) /

Floor mountings on concrete studs with platinum system /

Offset poles and water drains, with mechanically welded system, outside the terrace to enjoy the space /

Facade mounting with hollow-block, specific dowels in reinforced PVC and M16 lag bolts



Unique design

Contemporary architect house

Aix-en-Provence (13) - France

So'Design range

Technical & aesthetic solutions /

Suspended arch for a cantilever effect and offset for more volume /

Left post with shooting beam and offset water evacuation to enjoy a visual symmetry with the arch /

Floor mountings on concrete studs with platinum system and pebble to drain water in a landscape to maximize space in the terrace /

2 privacy screens for a light and shadow effect and aesthetically delimit areas for terrace and cars /

2 independent adjustable blade modules

Options /

Adjustable LED spotlights / Bicolour structure





Technical solutions

Private house

Ain (01) - France

So'Design range

Technical & aesthetic solutions /

Mounting on wooden frame by beam system, offset from the facade /

Technical solution for integration of the existing wooden post in a right side wing /

Tailor-made privacy screen reminding the 1st floor wooden cladding to hide the pole and get a visual harmony on the right side /

2 independent adjustable blade modules on the right side for the different living and dining areas + 1 kitchen module in the left /

Beam connecting the 2 pergolas to create a coherent part between the 2 elements /

Great height under the pergola to provide daylight in winter



Refined lines

Architect house
Marseille (13) - France
So'Design range

Technical & aesthetic solutions /

Invisible floor mounting on composite wood terrace and facade fixed on the balcony /

Aesthetic hanging arch to smooth the visual impression and enjoy a feeling of lightness /

XXL reach for an optimal terrace opening /

Straight tailor-made pole created as a bicolour decorative and functional shelf (towel holder and swimming pool accessories) and practical (structure support) /

2 independent adjustable blade modules

Options /

Adjustable LED spotlights / weather station /

bicolour structure







Life style

Contemporary architect house

Ain (01) - France

So'Design range

Technical & aesthetic solutions /

Special mountings with poles on the facade to avoid thermal gaps as the house insulation is from the outside /

Simple design arch / XXL reach between poles to open the window /

Nice height to enjoy the view and benefit from a maximum of sunshine in winter /

Floor mounting on tiled slab with lacquered platinum, same colours as poles

Options /

3 white zip blinds (1 central + 2 laterals) to protect from cool evening, from setting sun in summer and create a new protected living space /
bicolour structure



Reach the sky

Town architect house

Bourg-en-Bresse (01) - France

So'Design range

Technical & aesthetic solutions /

Carried by double bracing with 2m50 cantilever /

Central pole aligned with the facade to open the window /

Facade mounting offset by 80cm by beam, on a trapezium wall

to not have a pole on the facade /

Nice height to enjoy daylight in winter /

1 decorative privacy screen on the left for zip blind closure

Options /

2 zip blinds (1 central + 1 lateral) / Adjustable LED spotlights

A smart bioclimatic pergola

AN INNOVATIVE TECHNOLOGY DEVELOPED IN OUR FRENCH WORKSHOPS

Adjustable and motorized blades from 0° to 160° & Everyday comfort

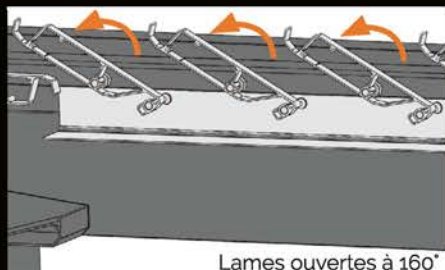

Lames ouvertes à 160°

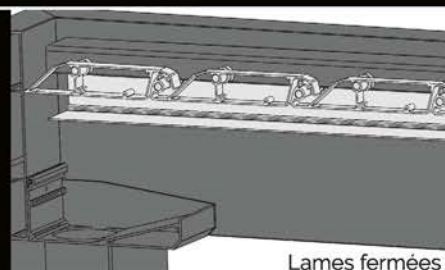

Lames fermées



MASTER THE SUNLIGHT ALL YEAR LONG & PROTECT YOURSELF

The blades of our pergolas are oriented from 0° to 160°, using a remote control, so you can perfectly control sunshine on your terrace as in the adjoining rooms. Our blades are white to optimize the reflection of light.

Open the blades to get more sun into the pergola and the adjoining rooms, to warm its and bring daylight in winter and mid season.

Half-open the blades to provide shadow and freshness under the pergola with natural ventilation in summer

Close the blades to enjoy your outdoors even when it rains

PRACTICAL & BEAUTIFUL

When functionality, design & practicality merged!

When the blades are fully closed, horizontally, they form a "flat roof". Our Solembra specificity : the blades have a top-and underside, allowing the blades in contact with the rain which get dirty faster, to not be visible under the pergola for "clean ceiling effect"

COMFORT, MOTORIZATION & HOME AUTOMATION

A bioclimatic pergola shall be characterized by enjoyment and conviviality.

At Solembra, we offer one of the quietest kinematics on the market. Smooth, fully motorized and remote controlled opening and closing blades.

Your multi-function remote control or your smartphone allows a full control of your pergola including all its options.

The best axes hold of the market & Security

We have carefully selected the highest quality aluminium and stainless steel to provide high performance and safety bioclimatic pergolas.

Our axes are in high quality stainless steel (solid) allowing the best resistance of the market to heavy loads and marine oxidation.

All our assemblies are tighten for a long-lasting axle hold, as well as a better resistance to bad weather (rain, wind, snow, etc.).

The optimal thickness of our aluminium gives **great rigidity to the structure and high solidity** for a perfect security of the overall installation.



High weather resistance & Serenity



Rain



Wind



Snow/frost



Rain sensor

WEATHER SENSORS

Optional, weather sensors (rain, wind, etc.), offer you a great comfort of life, by automatically protecting your terrace in case of bad weather.

For example, the rain sensor allows the blades to close automatically, from the first drops, to protect the terrace and the furniture underneath.

Even when you are away... you can go on vacation with your mind at ease!



Mobile gutter system

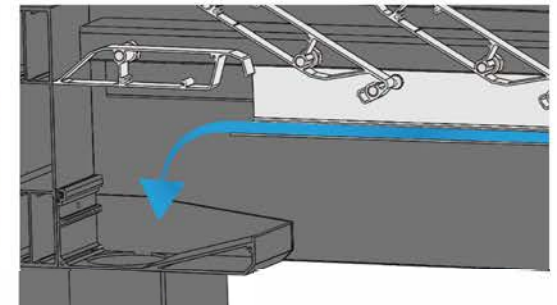

Water disposal

UNIQUE WATER DISPOSAL SYSTEM

Our **unique mobile gutter system** allows water collection from the blades and discharge it. They perfectly follow the adjustable blades movement to easily evacuate water. They prevent water from flowing down the structure and infiltrating the elements.

The water is then routed into the mobile gutter, in direct contact with the blade, and follows its route to the bioclimatic pergola pole(s) to drain it outwards.

Channels are completely invisible, perfectly integrated into the structure with a "seamless" effect.

High quality aluminium, personalized & Respect of the environment

EXTREME RESISTANCE & STAND THE TEST OF TIME

Material completely waterproof, protects perfectly from the rain. Particularly solid and robust, it withstands wind gusts perfectly. High resistance to negative temperatures in case of snow or frost. It helps to repel sunlight.

GREAT LONGEVITY & EASY MAINTENANCE

Easy to clean, karcher, soap and clear water rinsing. Twice a year is enough to make it shine. In spring, remove dead leaves, branches and stains from the adjustable blades for a perfect use.

INFINITE CUSTOMIZATION & AESTHETIC

The high-quality and ultra-resistant powder coating gives to your pergola a sophisticated and aesthetic touch that perfectly matches your taste. Its extreme finesse brings a charming asset to your exterior, for an elegant structure.

SUSTAINABLE & INFINITELY RECYCLABLE

The aluminium is one of the only renewable raw material, which can endlessly be recycled. Solembra is a committed company treating its waste responsibly, for a total recycling of used materials.



Leaned bioclimatic pergola

ENJOY FROM ALL THE BENEFITS OF THE "BIOCLIMATIC EFFECT"

Solembra's installations blend with all types of architectures, floors and existing structures (wood, steel, concrete, etc.)

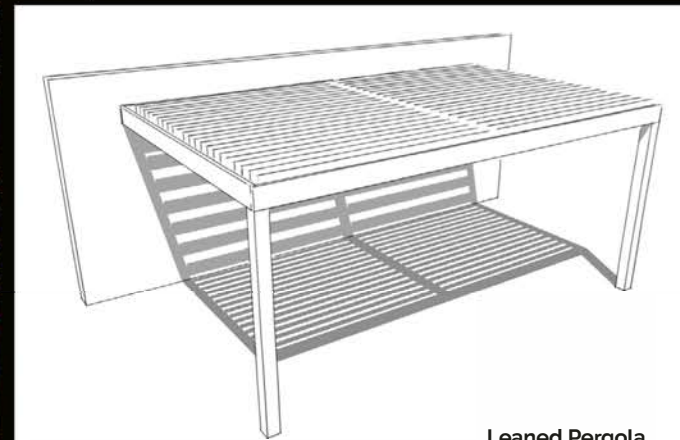

Leaned Pergola

Built in the house continuity, it creates an additional living room and regulates the temperature and light of the adjoining rooms. Our tailor-made solutions avoid thermal bridges.



Self-supported bioclimatic pergola

DESIGN YOUR EXTERIORS WITH A NEW LIVING AREA

Our pergolas are not necessarily square or rectangular, they can also be created in a trapezoid shape according to your needs.

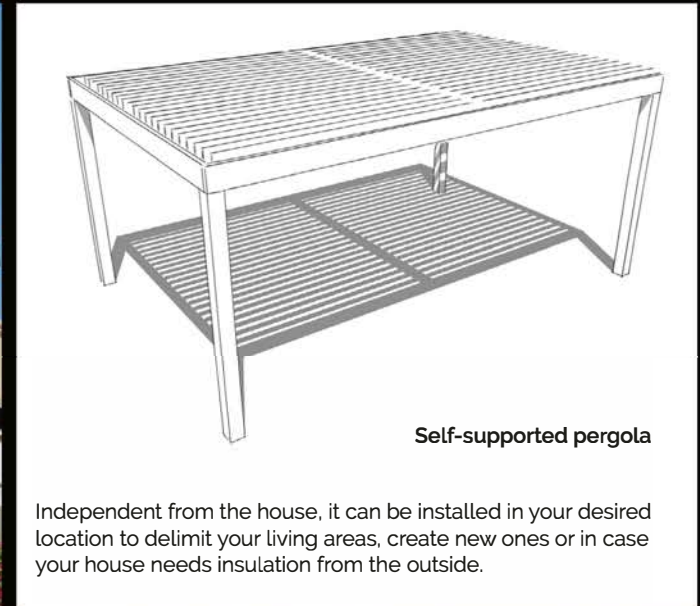

Open up the space

OFFSET / LIMITED POLES

XXL reach between poles, up to 10 m, imagine an infinite number of solutions... Our poles are perfectly integrated, "seamless"!

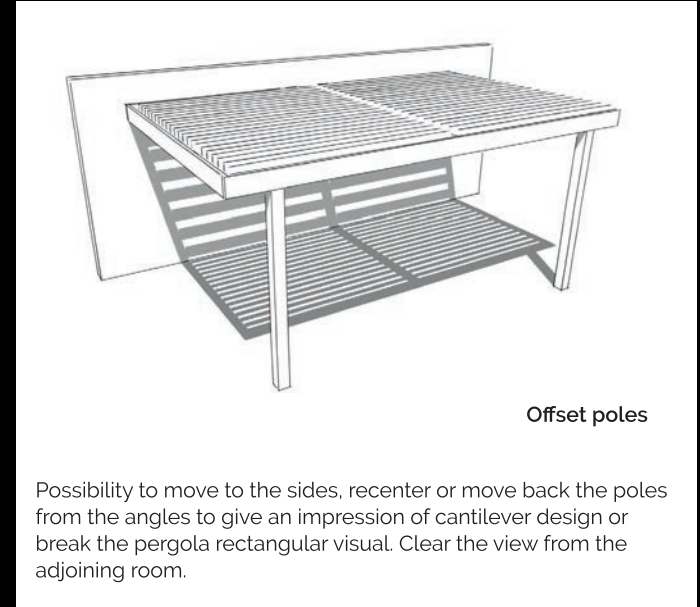

"Standard" poles 110x110 mm

"Improved" poles 150x150 mm

& clear the view

REMOVED POLES / BRACING

Bracing pergola

Bracing allows you to remove poles to enjoy an optimal opening on the outside & maximize the space on your terrace.

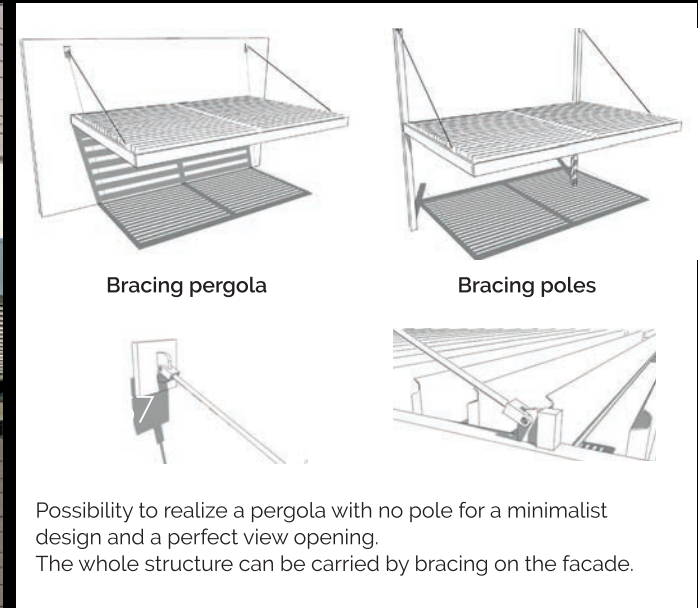

Possibility to realize a pergola with no pole for a minimalist design and a perfect view opening.
The whole structure can be carried by bracing on the facade.



A tailor-made pergola



with millimetre accuracy!



When technique meets beauty...

Infinite options...

CUSTOMIZE YOUR BIOCLIMATIC PERGOLA ACCORDING TO YOUR NEEDS

Let's create together a unique pergola in adequation to your needs, something you will see anywhere else!

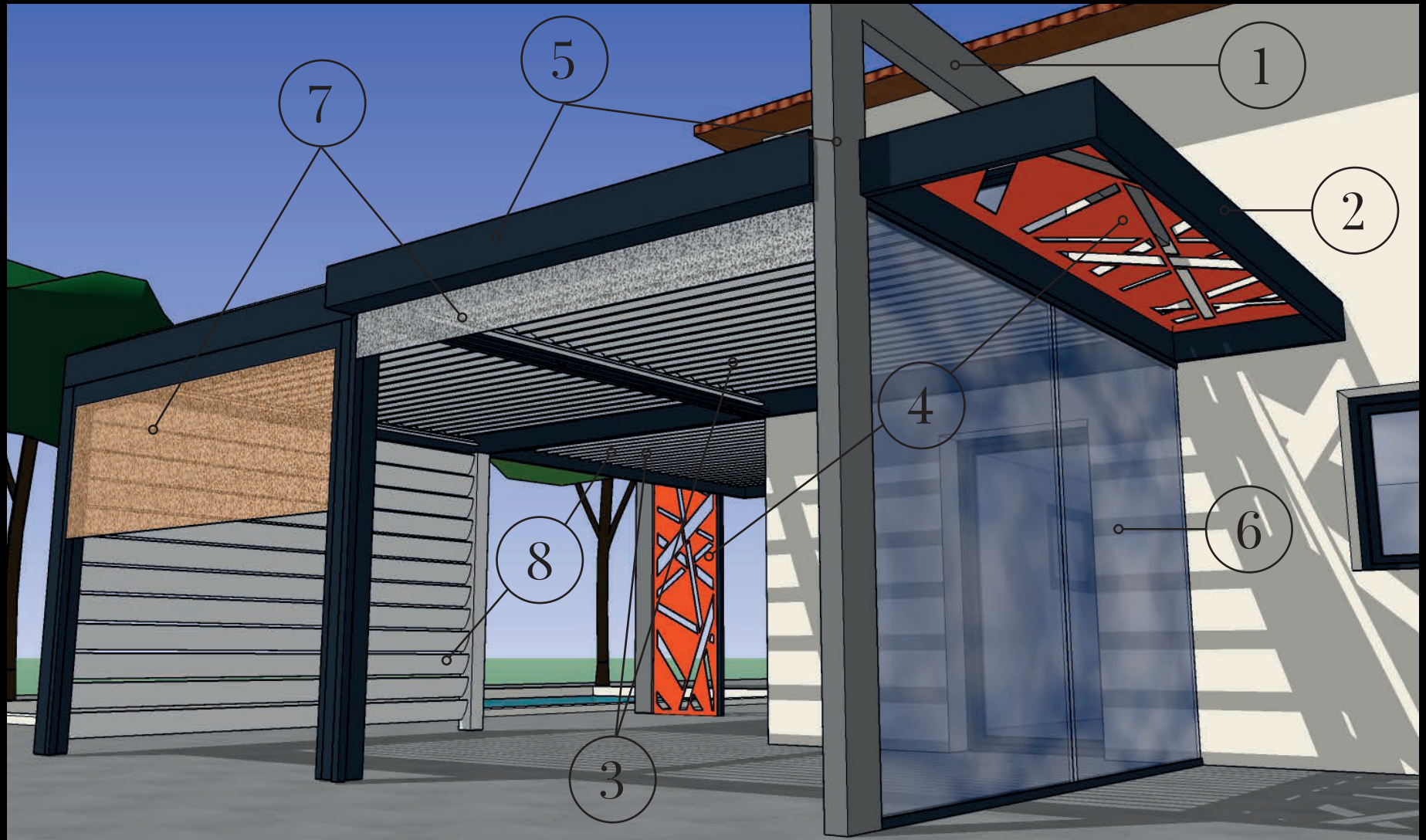

1 Arch



Add one or more arches to your pergola to give a touch of modernity to your house and open spaces.

4 Personalized colours



Over 400 finishes' shades to let your creativity decide. Colour combination possible. Colour chart on p.68-71

2 Roof overhang



Design your pergola with architectural lines and create a cantilever to expand the visual impression. An even more spectacular and unique finishing for your pergola.

6 Glazing / Window



Create a protected and pleasant living area, while giving a perfect view of the outdoors and nature.

3 2 depths or 2 heights

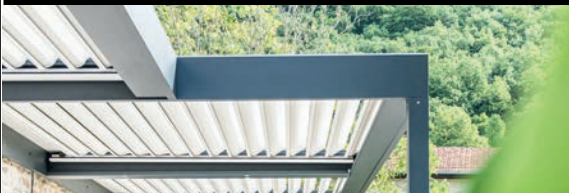

Play with different depths of your pergola, to delimit your terrace areas, or different heights, to create new spaces along your house lines.

7 ZIP blind



Protect yourself from the wind, rain, sun, evening freshness and vis-à-vis with ZIP blinds. Flush or surface-mounted blind. Several colours available. Colour chart on p. 74-75

4 Unique decorative privacy screen

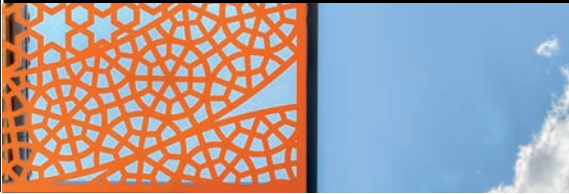

Add a light & shadow effect on your facade and floor. A design customization and a customized architectural in a wink, especially designed for you. Vertical or horizontal privacy screen.

8 Venetian blinds / Screen



Add a venetian blinds (horizontal) to protect an additional adjoining room of the house or a privacy screen (vertical) to protect from vis-à-vis.

Create an airy pergola

CHIPPED OF & SUSPENDED ARCHES: SIMPLE, DOUBLE, TRIPLE...

Bring a modern & unique touch to your pergola with slight and refined lines enhancing your home.

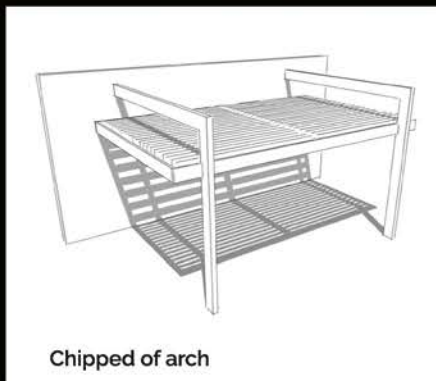

Chipped of arch

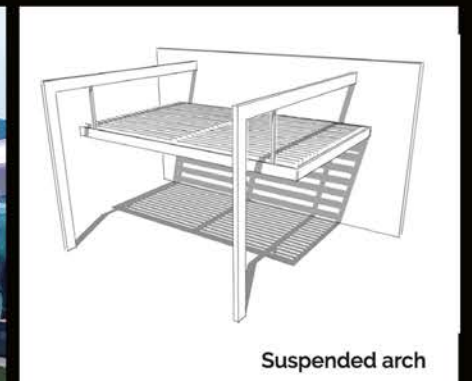

Suspended arch

& an architectural design

ROOF OVERHANGS

Open spaces and expand the visual impression of your pergola with architectural and minimalist lines.



Play with spaces

2 PERGOLAS' DEPTHS

Delimit spaces by playing on different depths.



& volumes

2 PERGOLAS' HEIGHTS (LAYERED PERGOLA)

Play with different heights, adapt it to your house design and create new outdoor spaces.



Sublimate your exteriors

DECORATIVE PRIVACY SCREENS

The privacy screen is the decorative and trendy touch to give a unique style to your terrace and turn your pergola into a work of art.



& beautify your house

PLAY WITH COLOURS

A personalized and harmonious finish to stand out in style.



Glazing

ENJOY THE VERANDA'S ADVANTAGES, WITHOUT DOWNSIDES!



The tempered glass closing system slides on parallel rails with a roller system integrated into the glazing.

Different opening systems available to clear the passage. The joints between each glazing make the unit airtight and watertight.

Windows have a secure closing system with handle and the possibility of locking the sliding doors. Create a new protected life area while having an amazing 360° view!

With your bioclimatic glazed pergola, you can half-open blades to create a natural ventilation and avoid a "suffocating effect" you might feel in a veranda.

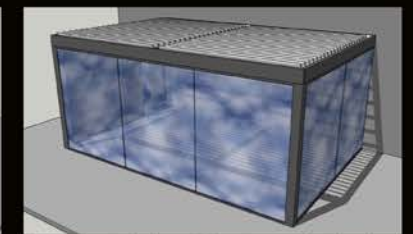
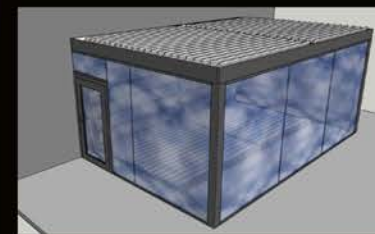

Permanent glazing with entrance by the door

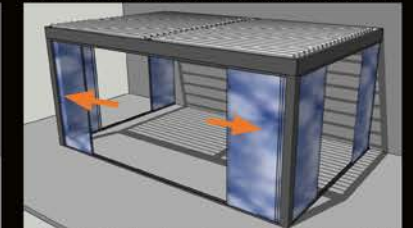
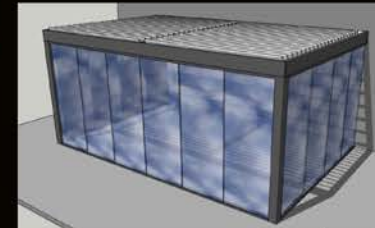

Opening system on each side to clear the space in the middle

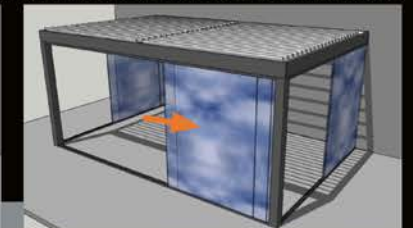
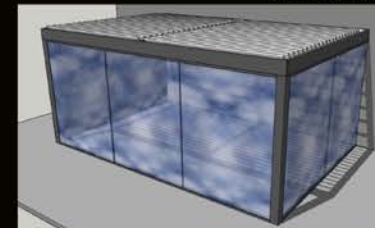

Opening system with one axle (1 permanent glazing and others sliding)

ZIP blinds

PROTECT YOURSELF & SEE WITHOUT BEING SEEN!



The vertical ZIP blind, perfectly integrated with bioclimatic pergola by a sliding system and controlled by remote control allows to:

- see through, without being seen, being protected from vis à vis
- protect from the wind, rain and sun
- protect from cool afternoons in mid-season
- create a "cocooning" atmosphere without the feeling of being locked up
- transform the pergola into a protected living space, out of sight
- Extend the pergola use for an additional 2 months a year (depending on the region)

LE SOLEMBRA * : we have developed a unique sliding system, very thin and customizable in the wall colour, for the installation of our zip blinds against the house's facade, in all discretion. An innovative and aesthetic solution which allows not to have an additional pole against the wall! (visual above)

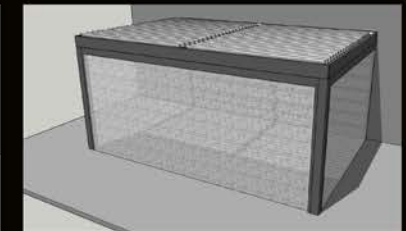
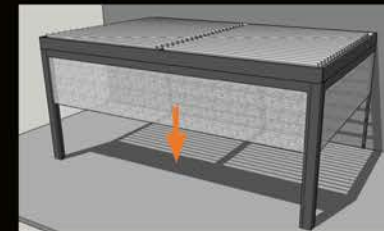

Zip blinds are flushed (box fixed under crossbars)

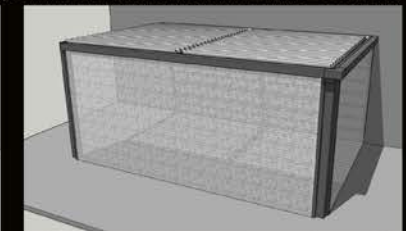
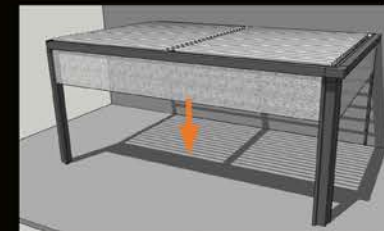

Surface-mounted Zip blind (box fixed against the crossbars on the outside)

Customize your blinds

A WIDE CHOICE OF COLOURS
ACCORDING TO YOUR WISHES !

Fiberglass fabric coated with high quality, long-lasting and easy to clean PVC coating.

PERFECT FINISH

"Seamless", large width textile bands up to an approximate element height of 2500 mm à 3200 mm. Without fold.

WEATHER RESISTANCE

Very good impermeability, lets air in slightly.
High elasticity which gives a strong wind resistance.

SUN PROTECTION

A fabric that can reflect up to 70 % of solar radiation. It holds back sunlight due to its structure in diagonal fabric. No more disturbing glare.
Dark colours optimize the reduction of glare effect

SEE WITHOUT BEING SEEN

True transparency : the secret lies in the fineness of the threads and the regular coating of glass fibers, the fabric uniformity, thus providing a great visibility, clear towards the outside and opacity towards the inside.

And even more options upon request...



Outside Inside

Grey / White-grey pearl 0161
n° 4850120

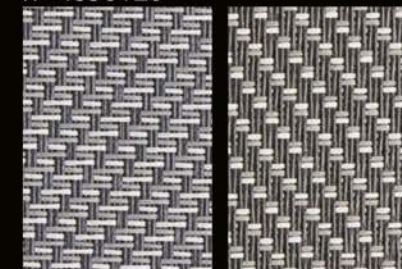

Outside Inside

White / White 0202
n° 4850160

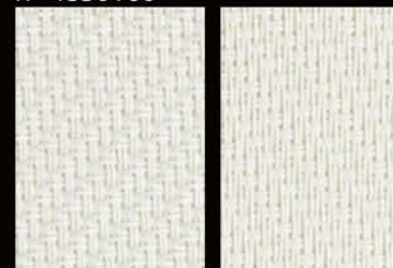

Pearl Grey / Pearl Grey 0707
n° 4850300



White / Pearl Grey 0207
n° 4850180

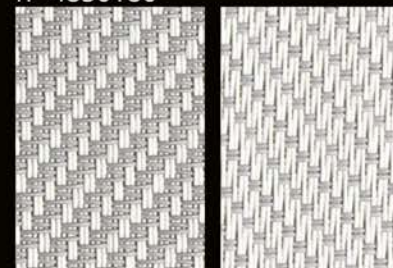

Oyster shell 3301
n° 4850480



Grey / White 0102
n° 4850020

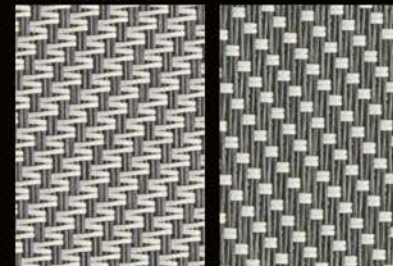

Grey / Grey 0101
n° 4850010

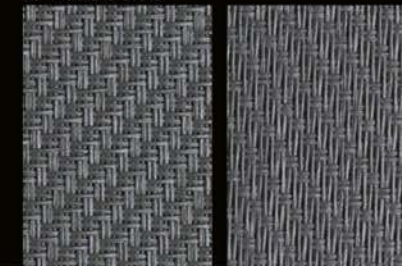

Outside

Inside

Grey / Charcoal 0110
n° 4850080

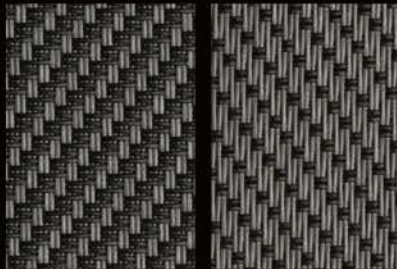

Outside

Inside

Linen / sand 0803
n° 4850350

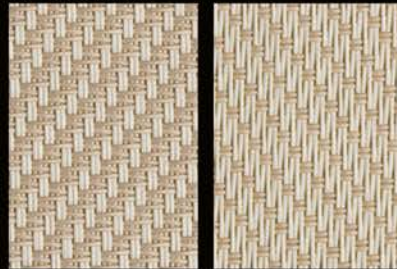

Outside

Inside

Jade river 3131
n° 4850450

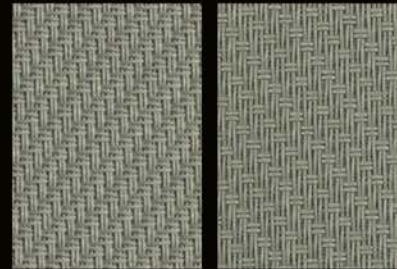

Face Extérieure

Inside

Bronze / Bronze 1111
n° 4850440



Charcoal / Charcoal 0110
n° 4850420

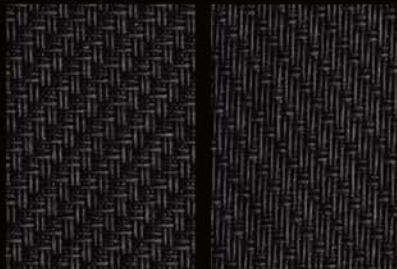

Linen / pearl grey 0807
n° 4850360

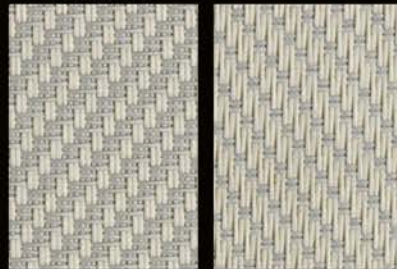

Linen / Grey-gold 0879
n° 4850400

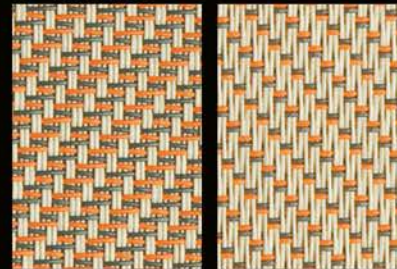

Charcoal / Bronze 1011
n° 4850430



Linen / White 0802
n° 4850340



Soft clay 3332
n° 4850490

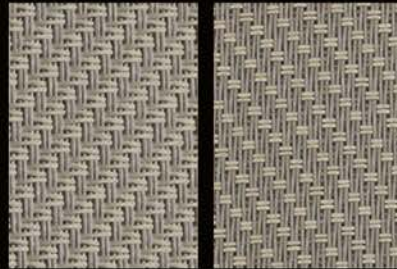

Grey / Mandarin 0105
n° 4850050

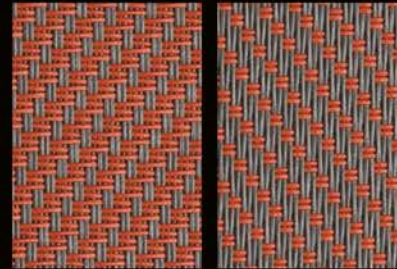

Grey / Blue Azure 0109
n° 4850070



Sand / White 0302
n° 4850200

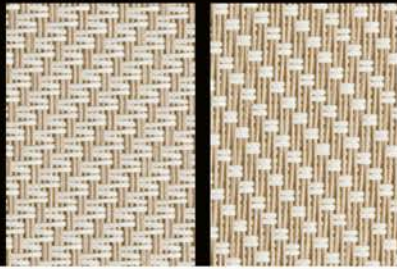

Duck egg 3231
n° 4850460

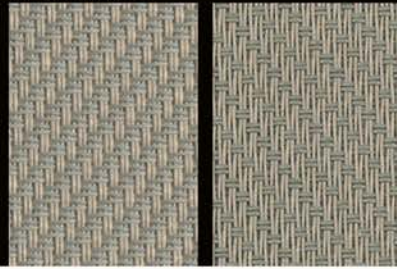

Roma Orange
n° 4852500

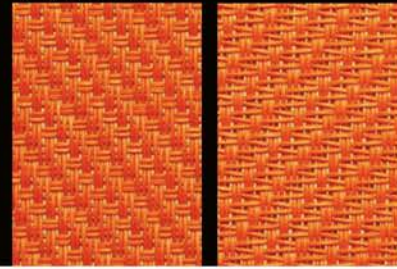

Grey / Yellow-green 0174
n° 4850150

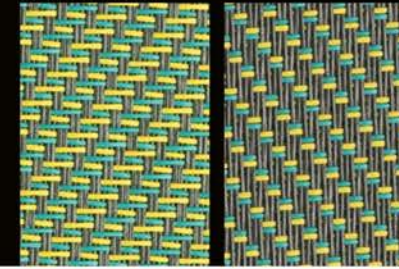

Outdoor life designer

Our ambition is to design unique and tailor-made bioclimatic pergolas, that suits you and adapt perfectly to your outdoor lifestyle.

With each new project, we make every effort to find the perfect, most efficient and aesthetic solution there is, and thus meet all of your expectations.



Weather sensors



Rendre sa pergola parfaitement autonome avec un capteur de pluie et/ou de vent. Une tranquillité et un confort de vie optimal sans avoir à se soucier de la météo, même en votre absence.

Heater element



Profiter de vos extérieurs même quand il fait frais ! Souvent installé en association avec des stores zip. Design et performances disponibles selon les besoins.

Water mist



Une brume de fraîcheur sur votre terrasse ! Idéal pour vous rafraîchir en cas de fortes chaleurs.

Audio system



Un système audio avec haut-parleurs pour écouter un son de haute qualité sur votre terrasse. Idéal pour vos soirées d'été !

LED lightings (remote)

Lighting system integrated into the pergola structure, "seamless".



LED strip RGB colours

Integrated into the internal structure perimeter, it projects an homogeneous light with chromatic effects to create personalized atmospheres. Can be controlled with your remote control to vary intensity and colours.



Adjustable LED spotlight

Get a direct lighting on your terrace. You can direct the light according to your needs and the lighting intensity you desire using your remote control.



White LED strip

Benefit from indirect lighting on your terrace with intensity control using your remote control. Specially designed for people sensitive to light.

Live as you wish...

Adjustable LED spotlight

DIRECT LIGHTING WITH VARIABLE INTENSITY

Extend your days under your pergola for a family or friends dinner with a light of adjustable intensity according to the spots' orientation.



White LED strip

INDIRECT LIGHTING WITH VARIABLE INTENSITY

Create a unique & cosy atmosphere under your bioclimatic pergola for a relaxing moment.



Quality & Design



Durability

The thickness of our aluminium offers solidity, robustness and an unbeatable resistance over time.



Security

Our structures are fully tightened for increased resistance to more common bad weather conditions.



Elegant lines

Our aluminium fineness offers clean and elegant lines to enhance your exteriors.



Unique drainage

Our innovative & unique mobile gutter system allows excellent rainwater drainage.



Silence

The kinematics we use is one of the quietest on the market.



Comfort

All of our pergolas are fully remote-controlled and motorized: inclination of blades, lights, zip blinds, etc.



Inertia

The ideal thickness of our aluminium prevents any deformation of the structure or the adjustable blades over time.



Respect of deadlines

The design, manufacturing and installation, fully internalized, allow us to control all of our deadlines and guarantee quality.





Technicality & Aesthetics



Exceptional design

Our greatest strength lies in the listening of your request to realize your dreamed pergola with architectural and airy lines.



Technical solutions

The innovative vision of our designers and the expertise of our design office allows us to find tailor-made technical solutions.



Perfect finishes

Powder cables, engine, fixing elements, evacuation ducts, and even options, can be integrated, "seamless".



Personalization

Infinite customization possibilities to create the pergola that suits you: arches, privacy screen, lateral wings, colours, options, etc.



Tailor-made

Fully tailor-made, to the millimeter, we configure the bioclimatic pergola in perfect harmony with your project.



Creativity

Our exceptional solutions give free rein to your creativity and desires to create a pergola in perfect harmony with its environment.



Easy maintenance

Our "flat roof" solution frees you from a daily maintenance, so the visible ceiling is always clean.



Aesthetic solutions

The architectural vision of our designers, combined with our design office perfectionism allow to realize all your exceptional & atypical projects!

Quality guarantees



COLORIMETRY
10 years

STRUCTURE
DEFORMATION
10 years



ELECTRIC
MOTORISATION
3 years



Find us on our website

solembra.pt

& join us on social media

@Solembra



A pergola project ?

Get your quote online

Tell us about your project and we will contact you as soon as possible to conceive together, the bioclimatic pergola of your dreams...

Get inspired by our achievements

Discover our photo gallery to imagine your future Solembra's pergola.

Subscribe to our newsletter

To receive our blog articles and keep you posted about our innovations & help you make the right choice.

website: www.solembra.pt



Your Solembra expert

Conceptance Lda

Exclusive distributor for Portugal

Goldra de Cima 186
8005-487 Santa Barbara
De Nexe (Faro)

mail : conceptanceda@gmail.com

www.solembra.pt

Facebook / Instagram / Pinterest @Solembra

**Solembra**